

REVISION	DRN BY	DRN DATE	CHK BY	CHK DATE	CHANGE DESCRIPTION
01	AL	28/10/20	-	-	Initial drawing
-	-	-	-	-	-
-	-	-	-	-	-

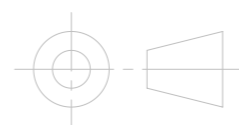

DEBURR AND BREAK SHARP EDGES
DO NOT SCALE DRAWING

UNLESS OTHERWISE SPECIFIED:
DIMENSIONS ARE IN MILLIMETERS
TOLERANCES:
LINEAR: +/- 0.1
ANGULAR: +/- 0.5

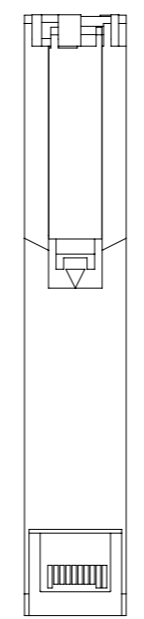
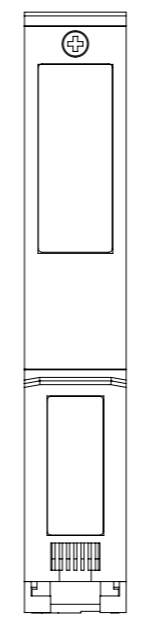
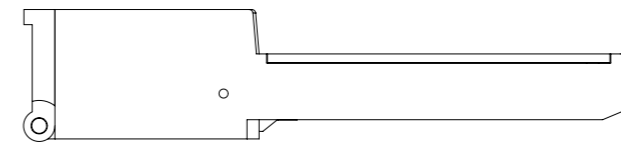
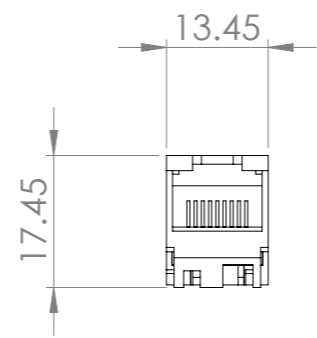
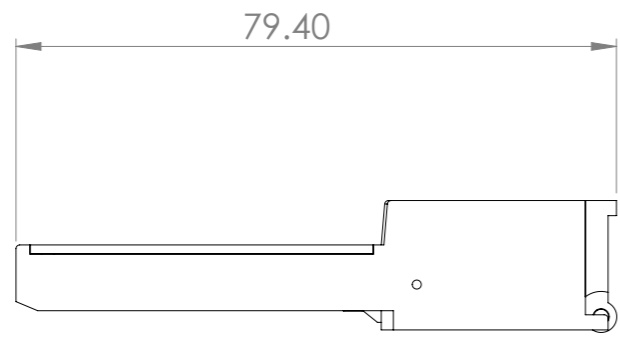

DWG NO. NA		REVISION 01	
TITLE: AMGSFP-VDSL2-R Dimensional Drawing		A3	
FINISH: NA	MATERIAL: NA		Document is property of AMG Systems Ltd and must not be shared, copied or printed without prior consent.
SCALE: 1:1		SHEET 1 OF 2	

REVISION	DRN BY	DRN DATE	CHK BY	CHK DATE	CHANGE DESCRIPTION
01	AL	28/10/20	-	-	Initial drawing
-	-	-	-	-	-
-	-	-	-	-	-

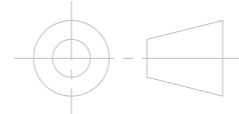
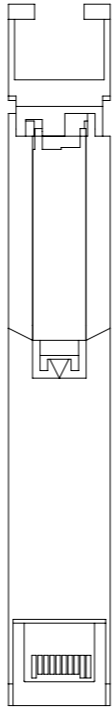
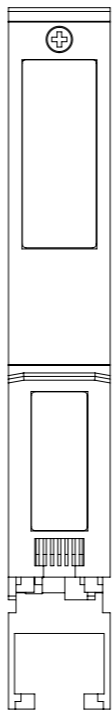
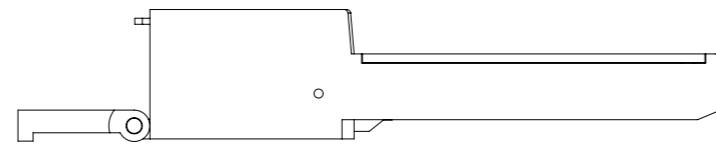
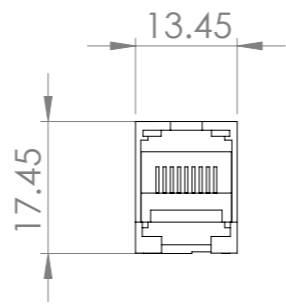
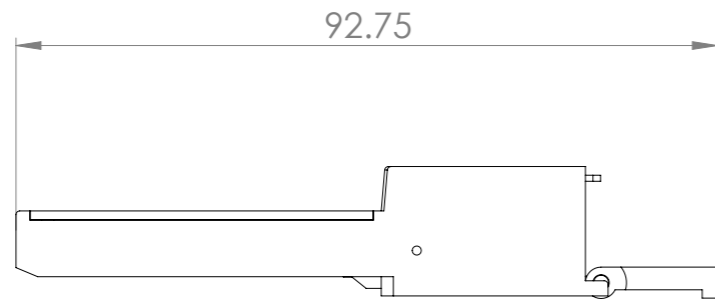

DEBURR AND BREAK SHARP EDGES
DO NOT SCALE DRAWING

UNLESS OTHERWISE SPECIFIED:
DIMENSIONS ARE IN MILLIMETERS
TOLERANCES:
LINEAR: +/- 0.1
ANGULAR: +/- 0.5



DWG NO. NA		REVISION 01	
TITLE: AMGSFP-VDSL2-R Dimensional Drawing		A3	
FINISH: NA	MATERIAL: NA	Document is property of AMG Systems Ltd and must not be shared, copied or printed without prior consent.	
SCALE: 1:1		SHEET 2 OF 2	