

REVISION	DRN BY	DRN DATE	CHK BY	CHK DATE	CHANGE DESCRIPTION
01	AL	14/10/21	-	-	Initial drawing
-	-	-	-	-	-
-	-	-	-	-	-

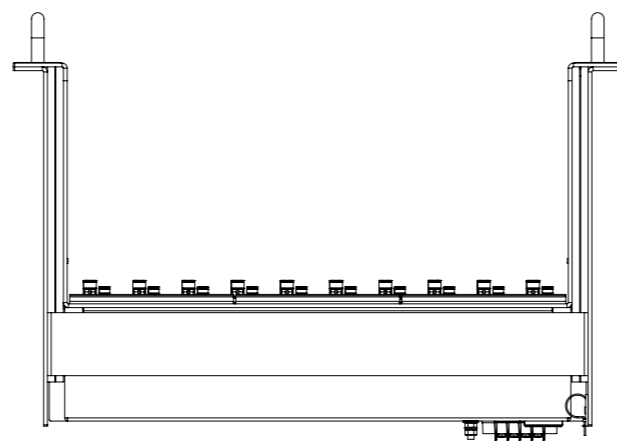

DEBURR AND BREAK SHARP EDGES
DO NOT SCALE DRAWING

UNLESS OTHERWISE SPECIFIED:
DIMENSIONS ARE IN MILLIMETERS
TOLERANCES:
LINEAR: +/- 0.1
ANGULAR: +/- 0.5

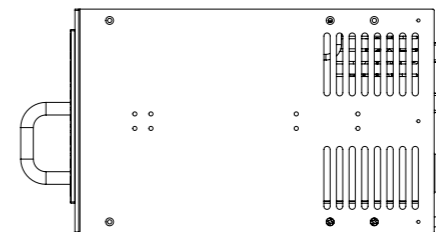
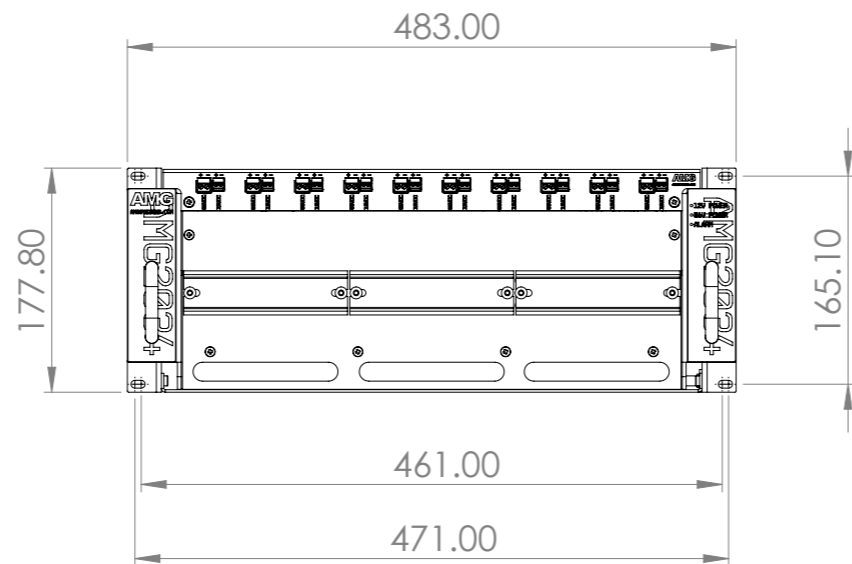
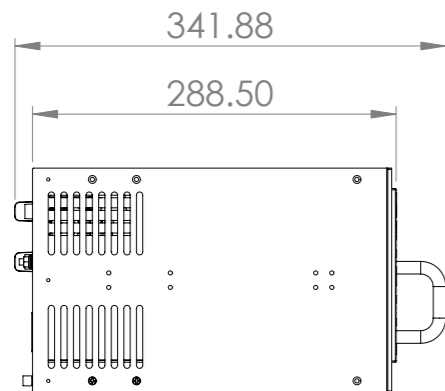
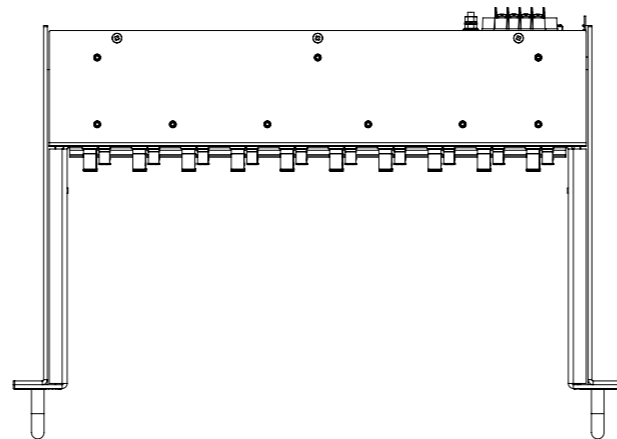

DWG NO. NA		REVISION 01
TITLE: AMG2034-1256-RP-AD Dimensional Drawing		A3
FINISH: NA	MATERIAL: NA	SHEET 1 OF 2
Document is property of AMG Systems Ltd and must not be shared, copied or printed without prior consent.		SCALE: 1:6

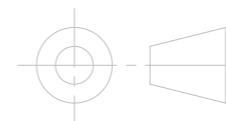

REVISION	DRN BY	DRN DATE	CHK BY	CHK DATE	CHANGE DESCRIPTION
01	AL	14/10/21	-	-	Initial drawing
-	-	-	-	-	-
-	-	-	-	-	-

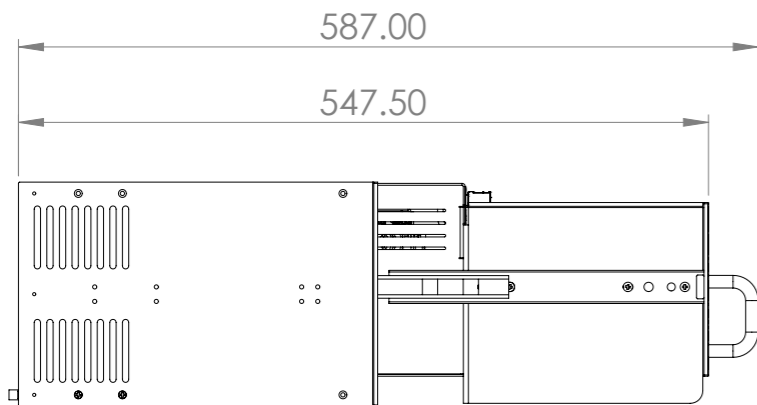
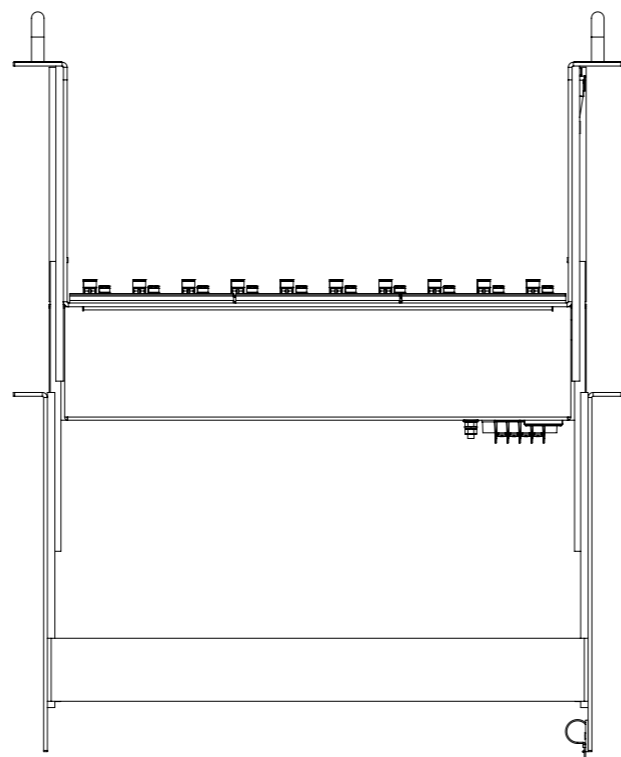
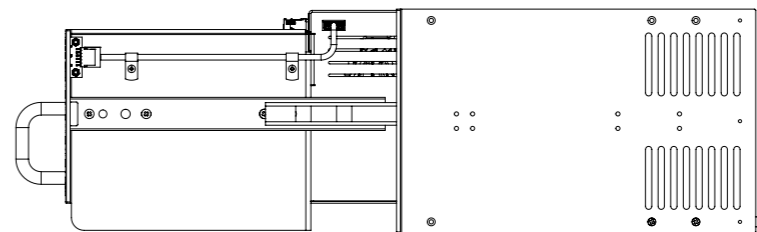
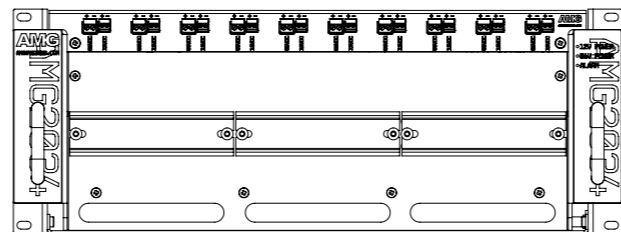
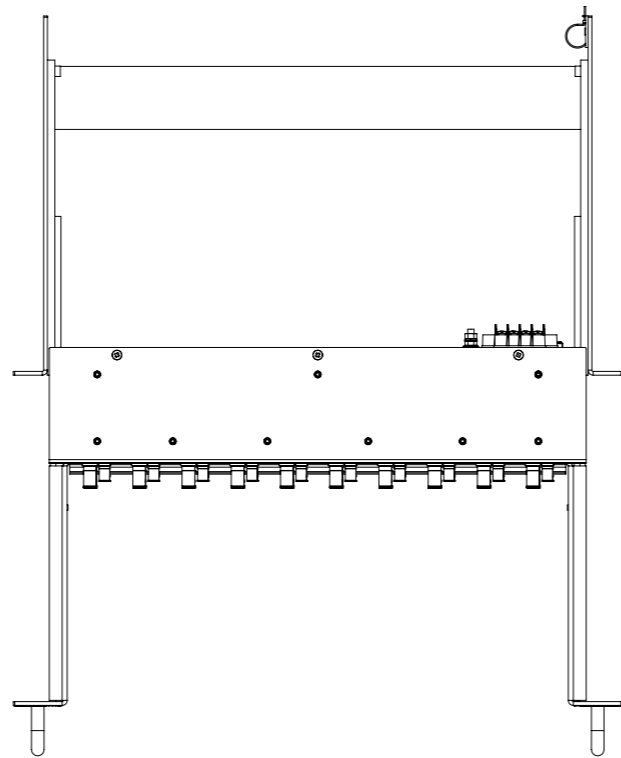

DEBURR AND BREAK SHARP EDGES
DO NOT SCALE DRAWING

UNLESS OTHERWISE SPECIFIED:
DIMENSIONS ARE IN MILLIMETERS
TOLERANCES:
LINEAR: +/- 0.1
ANGULAR: +/- 0.5



DWG NO. NA		REVISION 01	
TITLE: AMG2034-1256-RP-AD Dimensional Drawing		A3	
FINISH: NA	MATERIAL: NA	Document is property of AMG Systems Ltd and must not be shared, copied or printed without prior consent.	
SCALE: 1:6		SHEET 2 OF 2	

