

UNIT ALONE

REVISION	DRN BY	DRN DATE	CHK BY	CHK DATE	CHANGE DESCRIPTION
01	AL	19/10/20	-	-	Initial drawing
-	-	-	-	-	-
-	-	-	-	-	-

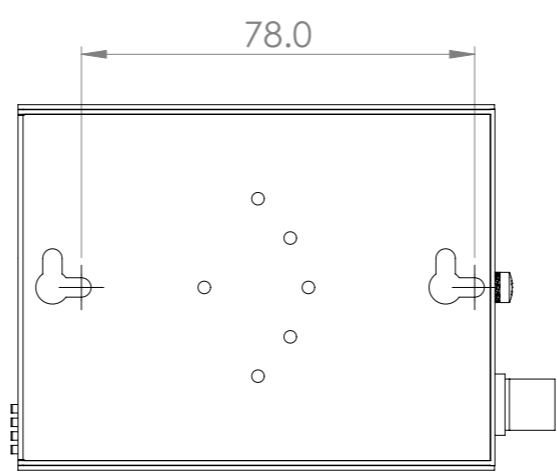
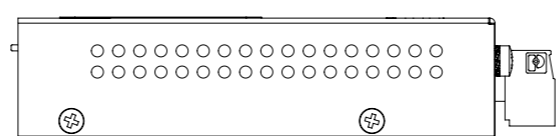
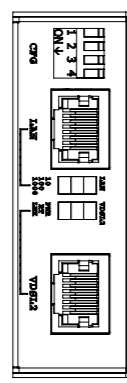
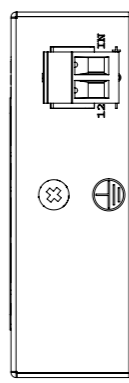
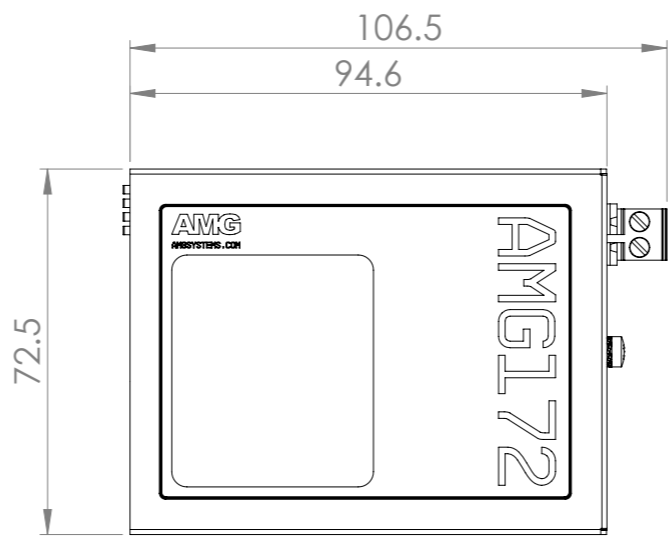
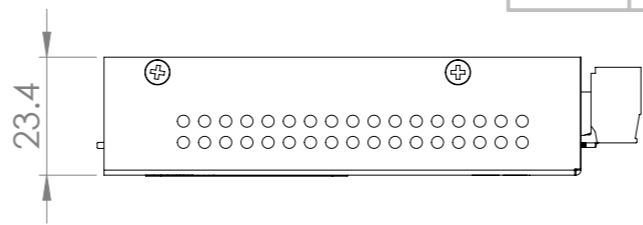

DEBURR AND BREAK SHARP EDGES
DO NOT SCALE DRAWING

UNLESS OTHERWISE SPECIFIED:
DIMENSIONS ARE IN MILLIMETERS
TOLERANCES:
LINEAR: +/- 0.1
ANGULAR: +/- 0.5

DWG NO. NA

TITLE: AMG172 Dimensional Drawing

FINISH: NA REVISION 01

MATERIAL: NA A3

Document is property of AMG Systems Ltd and must not be shared, copied or printed without prior consent. SCALE:1:1.5 SHEET 1 OF 3

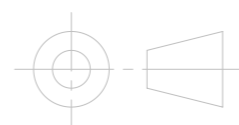

UNIT WITH 2-WIRE ADAPTER ATTACHED

REVISION	DRN BY	DRN DATE	CHK BY	CHK DATE	CHANGE DESCRIPTION
01	AL	19/10/20	-	-	Initial drawing
-	-	-	-	-	-
-	-	-	-	-	-

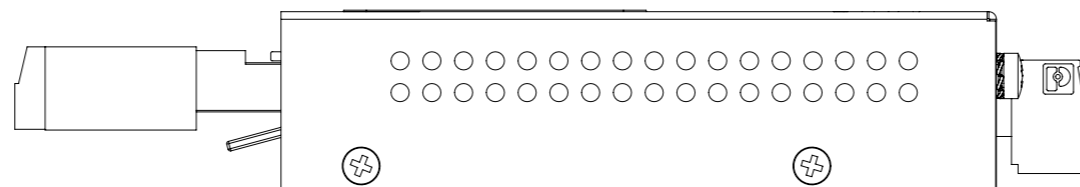
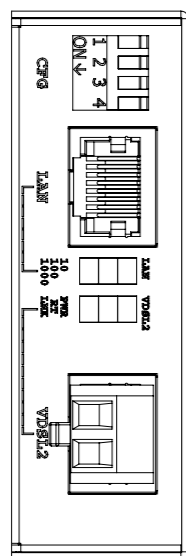
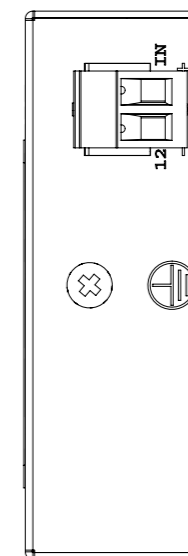
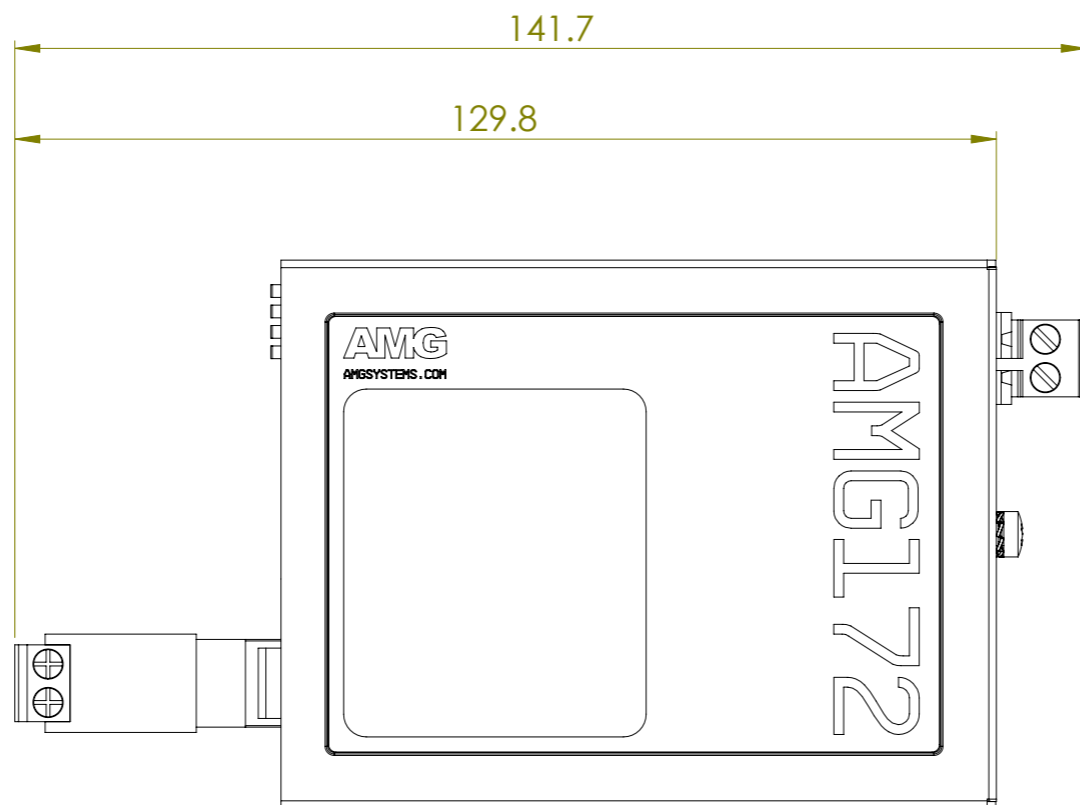
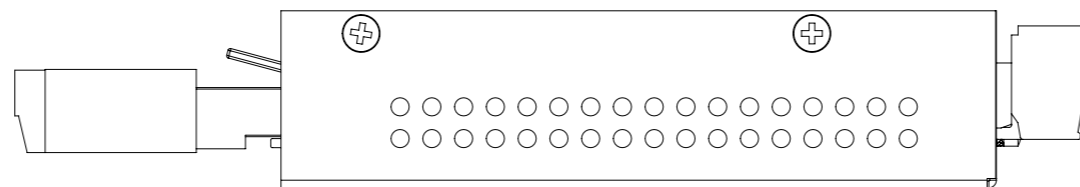

DEBURR AND BREAK SHARP EDGES
DO NOT SCALE DRAWING

UNLESS OTHERWISE SPECIFIED:
DIMENSIONS ARE IN MILLIMETERS
TOLERANCES:
LINEAR: +/- 0.1
ANGULAR: +/- 0.5



DWG NO. NA		TITLE: AMG172 Dimensional Drawing	
FINISH: NA	MATERIAL: NA	REVISION 01	A3
Document is property of AMG Systems Ltd and must not be shared, copied or printed without prior consent.		SCALE:1:1	SHEET 2 OF 3

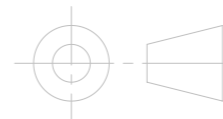

UNIT WITH BNC ADAPTER ATTACHED

REVISION	DRN BY	DRN DATE	CHK BY	CHK DATE	CHANGE DESCRIPTION
01	AL	19/10/20	-	-	Initial drawing
-	-	-	-	-	-
-	-	-	-	-	-

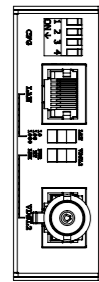
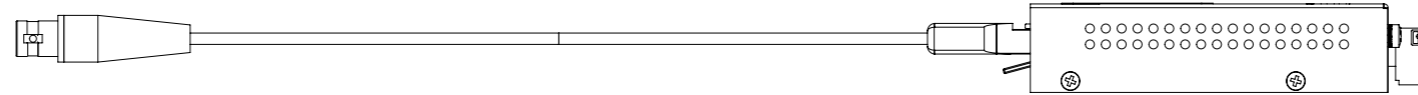
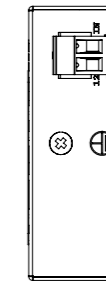
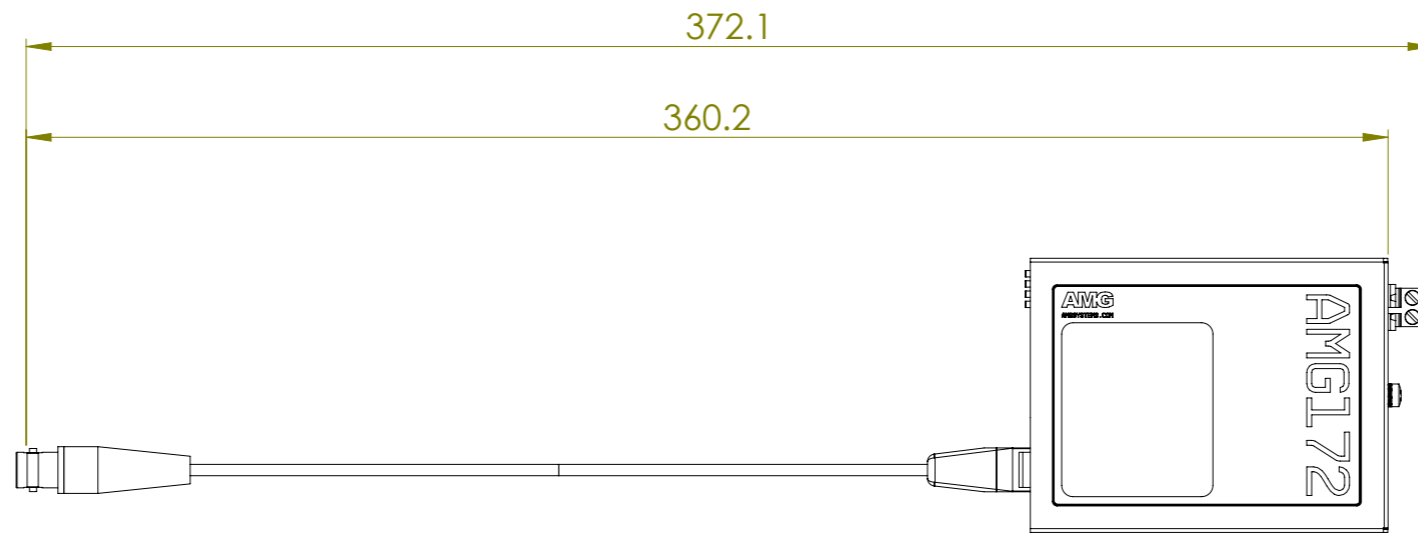

DEBURR AND BREAK SHARP EDGES
DO NOT SCALE DRAWING

UNLESS OTHERWISE SPECIFIED:
DIMENSIONS ARE IN MILLIMETERS
TOLERANCES:
LINEAR: +/- 0.1
ANGULAR: +/- 0.5

DWG NO. NA		TITLE: AMG172 Dimensional Drawing	
FINISH: NA	MATERIAL: NA	REVISION 01	A3
Document is property of AMG Systems Ltd and must not be shared, copied or printed without prior consent.		SCALE:1:2	SHEET 3 OF 3

